

# SUPERVAC

**Time Tested. Firefighter Proven.**

[supervac.com](http://supervac.com)

## Battery PPVs

Valor ..... 4-7

## Electric PPVs

Valor ..... 8

7 Series ..... 9

## Gas PPVs

Valor ..... 10

7 Series ..... 11

## Water Turbine PPVs ..... 12-13

## Confined Space ..... 12-13

## Smoke Ejectors

Battery ..... 14

Electric ..... 14

Gas ..... 15

Water Turbine ..... 15

## Large-Scale or Specialty PPVs

SVU ..... 16-17

Ventilation Vehicle ..... 17

Unmanned Misting Turbines ..... 18

Aircraft Brake Cooling Fans ..... 18

## Foam and Mist Generation ..... 19

## Smoke Generation ..... 20

## Ducts and Adapters ..... 20-21

## Fan Accessories ..... 22

Smoke Ejector Mounting ..... 22

Environmental Control ..... 22

## Chainsaw Conversion Kit ..... 23

## Super Vac's Air Cone Guard

The Air Cone Guard produces an air stream with a wider pattern, which creates pressure evenly across the fan's venturi. This pattern is useful for different ventilation scenarios, including open floorplans and large commercial structures, or when there is less room in front of doors, like stoops and small front porches.

Standard on all 7 Series PPVs + Smoke Ejectors

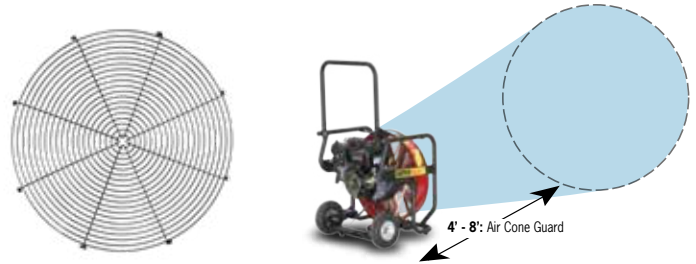

### Advantages of the Air Cone Guard

- ◊ Closer setup:  
Setback distance approximately 8'
- ◊ Perfect for:  
High-flow situations  
Small front porches  
Stoops  
Urban residential areas with numerous steps that limit space  
Narrow walkways in hotels, apartment complexes, etc.  
Hallways in hospitals, office buildings, etc.  
Rear entrances with decks
- ◊ Slightly less expensive and less weight
- ◊ Great for use in V-Attack
- ◊ Super Vac quality, backed with a 5-year warranty

## StreamShaper Guard

The StreamShaper Guard has a narrower air stream, which creates more pressure in front of the fan shroud, ideal for departments that need a precise airflow, usually in high-rise buildings and floorplans with numerous small rooms. This guard can be set farther from the building entrance, leaving more room for personnel to enter and exit the building.

Standard on all Valor Series PPVs

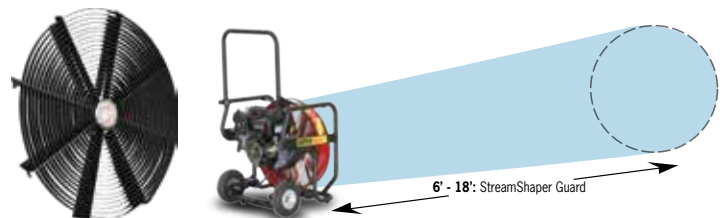

### Advantages of the StreamShaper Guard

- ◊ Farther setup:  
Setback distance up to 18'
- ◊ Perfect for:  
High-pressure situations  
High-rise buildings  
Homes with multiple small rooms  
Buildings with fewer entrance steps
- ◊ More room for operations at entrances
- ◊ Creates less noise
- ◊ Provides slightly higher airflow
- ◊ Great for use in V-Attack
- ◊ Super Vac quality, backed with a 5-year warranty



# FAN PLACEMENT INSTRUCTIONS

## Single-Fan Attack

The Air Cone Guard should be set back 4-8' from the door, while the StreamShaper Guard should be 6-18'. To keep ingress/egress routes clear during positive pressure operations, do not locate the fan directly in the doorway. Avoid standing in the doorway as it blocks airflow.

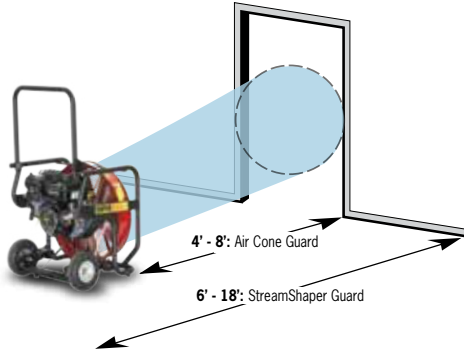

## Doorway V-Attack

The door is sealed top to bottom with the units at 45° angles in a doorway V-Attack, leaving a straight shot for attack lines.

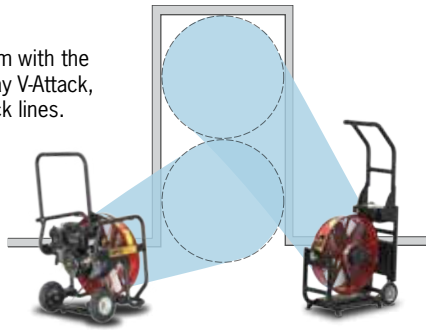

Older fan methods, like a Series Attack, aren't as effective as parallel methods.

## Garage Door V-Attack

When using a garage door, open it part way and seal the doorway with the cones of air from two fans.

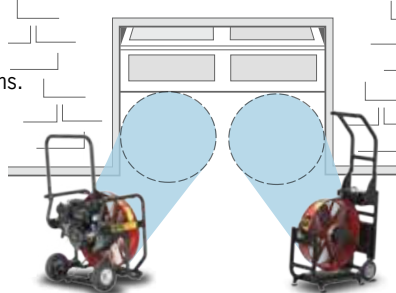

Do not block the air supply by standing behind the fan.

## Fan Setback

As mentioned on Page 2, Super Vac's guard choices provide different setback options. The below diagram demonstrates how different setbacks can effect entrained airflow.

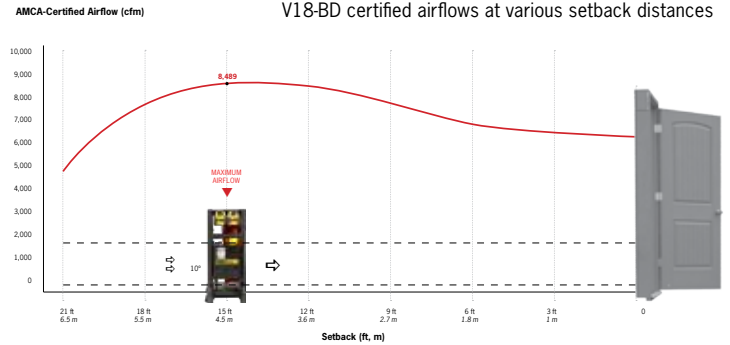

## Extension Cord Use

Extension cords work in much the same way as a fire hose — the longer the cord, the less voltage at its workable end. In short, more pressure is required for 100 gpm at the end of a 400 foot 1-1/2" hose than for 100 gpm at the end of a 50 foot 1 1/2" hose. To overcome this, use extension cords with heavier wires, which conduct more electricity and result in lower voltage drop. Note: An undersized cord can cut the fan's performance below motor nameplate specifications, and if the cord is not completely unrolled, the unrolled portion produces a counter EMF (electromotive force), which in effect reduces the cord's current carrying ability.

**WARNING:** Never exceed cable extension lengths or use reeled or coiled cable. Always use required wire gauge and ensure the power supply can handle wattage requirements. If the cord size/length are nearing recommend limits (left), pull the entire length of cord off the reel or replace with a larger cord.

SUPER VAC HP	QTY	STARTING WATTAGE REQUIRED	MAXIMUM CABLE EXTENSION LENGTHS								
			Meters	25	50	75	100	150	350		
1/3*	1	2000	14 GA								
			12 GA								
			10 GA								
1/2*	1	2000	14 GA								
			12 GA								
			10 GA								
	2	4000	10 GA								
			8 GA								
	3	6000	8 GA								
			6 GA								
1*	1	4000	12 GA								
			10 GA								
			8 GA								
	2	8000	10 GA								
			8 GA								
1 1/2	1	6000	10 GA								
			8 GA								
	2	12000	8 GA								
			6 GA								
			4 GA								

\* For 220V fans, double the maximum length cable extensions.

## AMCA 240-22 Certified Airflows

The listed battery fan ratings in this catalog are based on tests and procedures in accordance with AMCA Standard 240-22. All other outputs in the battery fan charts are based on results from comparable AMCA 240-22 testing procedures. The AMCA 240 Standard was revised in 2022 to specifically test battery-powered PPV fans and was created in collaboration with industry experts, select firefighters and PPV manufacturers. The new test reflects improved variables, including:

- 1 A smaller doorway (to match international standards)
- 2 Constant power supply (since battery power drops over time)
- 3 Documentation of battery runtimes (to assure accuracy)

These variables deliver more accurate, yet lower airflows compared to identical fans tested to the old AMCA 240-16 standard.



Learn more about the AMCA Standard 240 Test [supervac.com/amca-certified-fans](http://supervac.com/amca-certified-fans)

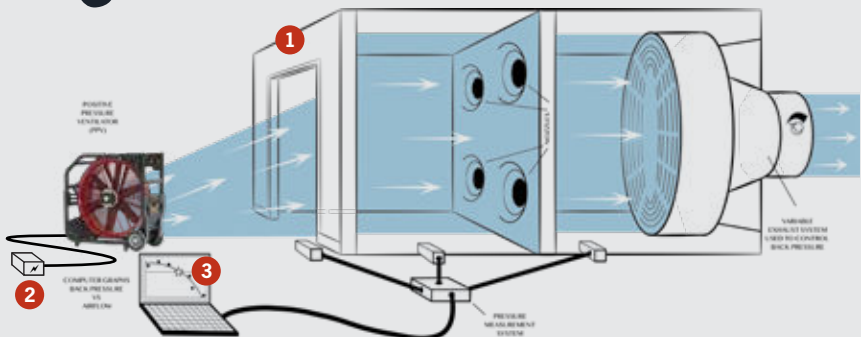

# BATTERY PPVs

## WORKS WITH DEWALT

Dual 9.0Ah, 12.0Ah and 15.0Ah  
FLEXVOLT batteries



## MILWAUKEE

M18 XC 8.0Ah or HD 12.0Ah batteries  
M28 XC 3.0Ah or XC 5.0Ah batteries (upon request)



## MAKITA

XGT 4.0Ah, 5.0Ah or 8.0Ah batteries



**U.S. PATENT NOS. 11,131,321 AND 11,795,970 AND PATENTS PENDING**





Watch us throw a battery fan off a building!  
[bit.ly/torture-test-video](http://bit.ly/torture-test-video)

# YOU PICK THE BATTERY PLATFORM. WE'LL BRING THE FAN ...

**Never in firefighter history** has one fan worked with your department's other battery-operated tools. Until now. The all-new Super Vac 16", 18" and 20" variable-speed battery fans, which operate with your choice of DeWalt®, Milwaukee® or Makita® batteries, are the most compatible PPVs on the market. Gone are the days of expensive, hard-to-source batteries that take more than half a day to charge. Finally, the industry can turn to a fan with trusted battery names that pair with Super Vac's dependable history.

See next page for specs.

## KEY FAN FEATURES

- 1  **Compact, Roll-Cage Aluminum Frame:** Features one of the most compact, lightweight PPV designs
- 2  **Curved Handle:** Folds into the frame of our 16" (-WH models), 18" or 20" models for compact storage; curved design provides higher grip for better ergonomics
- 3  **Flat-Proof Rubber Tires with Stair Skid Plates:** Creates a highly maneuverable 16" (-WH models), 18" or 20" fan; easy for all firefighters to position without bending over
- 4 **Polymer Blade:** Minimizes weight; cast aluminum blades are available by request
- 5 **StreamShaper Guard:** Allows flexible setback; Air Cone Guard is available by request
- 6 **Standard Shore Power:** 120-240V AC operation is standard (with optional delete)



**5-YEAR WARRANTY**

3-YEAR WARRANTY ON MOTOR

## 180° OF SEPARATION

We have all the angles of attack covered — and then some. You won't find another battery fan that offers 180 degrees of tilt like the Super Vac battery fan.



For attic attacks

For positive tilt attacks

Storage angle

For negative tilt attacks

For manhole attacks

## SPECIFICATIONS



The 16" – Two frame designs!

### 16" Blades - H x W x D: 22.75" x 23" x 12" - 580 mm x 585 mm x 305 mm

Models	Weight with Batteries	Motor	Runtime at Max Airflow	Setback For Output Rating	Angle For Output Rating	AMCA 240-22 Certified Output
V16-BD-SP (DeWalt FLEXVOLT)	45 lbs 20 kg	Variable-Speed DC with Standard 120-240V AC	9.0Ah (2) - 40 minutes 12.0Ah (2) - 53 minutes 15.0Ah (2) - 66 minutes	15 ft 4.6 m	10°	8,127 cfm* 13,808 cmh
V16-BL-SP (Milwaukee M18)	45 lbs 20 kg	Variable-Speed DC with Standard 120-240V AC	XC 8.0Ah (2) - 31 minutes HD12.0Ah (2) - 46 minutes	15 ft 4.6 m	10°	7,721 cfm* 13,118 cmh
V16-BW-SP (Milwaukee M28)**	45 lbs 20 kg	Variable-Speed DC with Standard 120-240V AC	XC 3.0Ah (2) - 31 minutes XC 5.0Ah (2) - 52 minutes	15 ft 4.6 m	10°	8,084 cfm 13,735 cmh
V16-BK-SP (Makita XGT)	46 lbs 21 kg	Variable-Speed DC with Standard 120-240V AC	4.0Ah (2) - 32 minutes 5.0Ah (2) - 39 minutes 8.0Ah (2) - 62 minutes***	15 ft 4.6 m	10°	7,921 cfm 13,458 cmh

Add -WH to model to upgrade to Wheel/Handle design. Note: Add ~8 lbs. (4 kg) to -WH models; -WH models are 24.25" x 23.75" x 12.25".

\*\*\*Makita XGT 8.0Ah battery available for V16-BK-SP-WH model but not for V16-BK-SP.

### 18" Blades - H x W x D: 25.50" x 26" x 12.25" - 650 mm x 660 mm x 315 mm



The 18" – Made to maneuver

Models	Weight With Batteries	Motor	Runtime at Max Airflow	Setback For Output Rating	Angle For Output Rating	AMCA 240-22 Certified Output
V18-BD-SP (DeWalt FLEXVOLT)	58 lbs 26 kg	Variable-Speed DC with Standard 120-240V AC	9.0Ah (2) - 35 minutes 12.0Ah (2) - 56 minutes 15.0Ah (2) - 69 minutes	15 ft 4.6 m	10°	8,489 cfm* 14,423 cmh
V18-BL-SP (Milwaukee M18)	58 lbs 26 kg	Variable-Speed DC with Standard 120-240V AC	XC 8.0Ah (2) - 36 minutes HD 12.0Ah (2) - 53 minutes	15 ft 4.6 m	10°	8,946 cfm* 15,200 cmh
V18-BW-SP (Milwaukee M28)**	56 lbs 25 kg	Variable-Speed DC with Standard 120-240V AC	XC 3.0Ah (2) - 29 minutes XC 5.0Ah (2) - 47 minutes	15 ft 4.6 m	10°	8,416 cfm 14,299 cmh
V18-BK-SP (Makita XGT)	56 lbs 25 kg	Variable-Speed DC with Standard 120-240V AC	4.0Ah (2) - 36 minutes 5.0Ah (2) - 45 minutes 8.0Ah (2) - 66 minutes	15 ft 4.6 m	10°	8,456 cfm 14,382 cmh

### 20" Blades - H x W x D: 28.25" x 28.75" x 12.5" - 720 mm x 730 mm x 320 mm



The 20" – Maximum output!

Models	Weight With Batteries	Motor	Runtime at Max Airflow	Setback For Output Rating	Angle For Output Rating	AMCA 240-22 Certified Output
V20-BD-SP (DeWalt FLEXVOLT)	63 lbs 29 kg	Variable-Speed DC with Standard 120-240V AC	9.0Ah (2) - 35 minutes 12.0Ah (2) - 46 minutes 15.0Ah (2) - 58 minutes	15 ft 4.6 m	10°	9,456 cfm* 16,066 cmh
V20-BL-SP (Milwaukee M18)	62 lbs 28 kg	Variable-Speed DC with Standard 120-240V AC	XC 8.0Ah (2) - 41 minutes XD 12.0Ah (2) - 67 minutes	15 ft 4.6 m	10°	9,867 cfm* 16,764 cmh
V20-BW-SP (Milwaukee M28)**	61 lbs 28 kg	Variable-Speed DC with Standard 120-240V AC	XC 3.0Ah (2) - 26 minutes XC 5.0Ah (2) - 43 minutes	15 ft 4.6 m	10°	9,596 cfm 16,304 cmh
V20-BK-SP (Makita XGT)	61 lbs 28 kg	Variable-Speed DC with Standard 120-240V AC	4.0Ah (2) - 35 minutes 5.0Ah (2) - 45 minutes 8.0Ah (2) - 70 minutes	15 ft 4.6 m	10°	9,773 cfm 16,604 cmh

DeWalt batteries required in pairs. Use only batteries' proprietary charging equipment to charge batteries.

120-240V AC operation is standard (with optional delete). AC (shore power) needed to run the fan = 1 kW.

Conservative run times are based on humidity, temperature, elevation and battery condition with a pair of batteries inserted.

Delete -SP from model to remove standard shorepower.

\*The listed ratings are based on tests and procedures in accordance with AMCA Standard 240-22. All other outputs in this chart are based on results from comparable AMCA 240-22 testing procedures. The AMCA 240 Standard was revised in 2022 to specifically test battery-powered PPV fans and was created in collaboration with industry experts, select firefighters and PPV manufacturers. The new test reflects improved variables, including a smaller doorway (to match international standards), constant power supply (since battery power drops over time) and documentation of battery runtimes (to assure accuracy). These variables deliver more accurate, yet lower airflows compared to identical fans tested to the old AMCA 240-16 standard.

\*\*For M28 batteries or chargers, please see your Genesis, TNT or Weber dealer.

DeWalt, Milwaukee and Makita\* batteries and chargers also available.

# ACCESSORIES



## Magnetic Mountain Mister

Attach a garden hose or auxiliary line from any apparatus pump to the Mountain Mister. The mister then fixes to the fan shroud using industrial magnets (MM-MAG), converting the battery fan into a rehab cooling unit. (Only consumes 3 gallons of water per hour!)

Model	Pairs With
MM-MAG	Battery PPVs or any PPVs with StreamShaper Guards



## Door Bar / Hanger

The Super Vac Hanger allows crews to hang a smoke ejector or battery fan from virtually anywhere — from ladders and in doorways, windows, basements, archways and more. Used in conjunction with the Door Bar, these two accessories permit fan placement at any height. The Door Bar features a pull trigger for quick release.

Model	Pairs With
HR	Battery PPVs / Smoke Ejectors

Model	Weight	Usable Range
DOOR BAR	13 lbs 6 kg	26"-60" with extensions

A single Extension Bar is standard. Additional bars can be purchased separately.



## Truck / Running Board Mount

These mounts allow crews to secure a Super Vac 16", 18" or 20" battery fan inside a compartment for secure transportation.

Model	Pairs With
TM16	16" Battery PPVs
TM16-WH	16" -WH Battery PPVs
TM18	18" Battery PPVs
TM20	20" Battery PPVs



## Carry Strap

Carry Super Vac's 16", 18" or 20" battery fan with this 2-inch vinyl strap, featuring shoulder pad and adjustable length for different carrying styles.

Model	Pairs With
BDSS	16", 18" and 20" Battery PPVs



## Spiral Ducts

Super Vac's Spiral Ducts are ideal for moving large quantities of air into hard-to-reach places and come with a built-in storage/carry bag for easy transportation. Hot-melt wear strips cover the helix for added durability up to 250° F.

Model	Diameter	Length
16x20BC1 (16" Fans)	16" 406 mm	20' 6.1 m
20x20BC1 (18" and 20" Fans)	20" 508 mm	20' 6.1 m

## High-Expansion Foam Adapter

This foam adapter attaches easily to any Super Vac battery fan, as well as Super Vac PPVs (from 16"-30") and Smoke Ejectors (from 16"-24") and is capable of producing foam up to an expansion rate of 1000:1 for tough extinguishments, including oil and mining operations, ship-hold areas and flammable liquid scenes.

Model	Pairs With
HXG-PPV	Battery PPVs and 16"-30" PPVs

Includes: Metal shroud, foam expansion netting, a 30 GPM in-line educator and 1 1/2" NH hose adapter. Please specify fan model when ordering.

For Smoke Ejector model details, please see Page 19.



# ELECTRIC PPVs

## VALOR

**5-YEAR  
WARRANTY**



The Valor Series is among the latest in Super Vac PPV innovations. Featuring an intuitive frame design that is easy to position on the fireground, the Valor is engineered to ease the toughest ventilation challenges.

- 1 Full Roll-Cage Frame:** Features a tough, tubular aluminum frame to protect key components; delivers a lightweight design (15% lighter than steel frames)
- 2 7-Position Tilt Frame with Step Pad:** Provides 18°, 12°, 6°, 0°, -6°, -12° and -18° angles; allows for fan placement on stairs
- 3 Fold-Down Ergonomic Handle:** Folds down into frame for compact storage; features full-width handle for easy grip with heavy-duty gloves
- 4 Flat-Proof Rubber Tires:** Eliminates flat tires; rolls up stairs and curbs easily; tires are placed on the back of the frame so that firefighters never have to put themselves between the PPV and the fire during setup
- 5 Single-Piece Cast Aluminum Blade:** Holds up better than plastic in high heat
- 6 Precision-Spun Steel Shroud:** Provides durability with maximum airflow
- 7 StreamShaper Guard:** Standard guard, designed for farther setback; Air Cone Guard available by request
- 8 AMCA-Certified Airflow:** Super Vac is proud to enlist AMCA (the Air Movement and Control Association) as an independent organization to conduct third-party performance tests.



### 18" Blades - H x W x D: 23.5" x 22" x 21" - 600 mm x 560 mm x 535 mm

Model	Weight	Motor	RPM	Start	Run	Setback	Angle	Output
V18-ES	80 lbs 36.5 kg	Bluffton, single speed, 1 HP, 50/60Hz, 115/230V AC	1,783	4,000 w 15-amp circuit	1,500 w	9 ft 2.7 m	13°	6,378 cfm 10,836 cmh
V18-EX	90 lbs 41 kg	Bluffton, single speed – hazardous location rated for Class 1 Group D, 1 HP, 50/60Hz, 115/230V AC	1,783	4,000 w 15-amp circuit	1,500 w	9 ft 2.7 m	13°	6,378 cfm 10,836 cmh
V18-EV	84 lbs 38 kg	RAE, TEAO variable speed, 1.5 HP, 50/60Hz, 115/230V AC	2,368	2,000 w 15-amp circuit	1,500 w	9 ft 2.7 m	11.5°	11,709 cfm 19,894 cmh

### 20" Blades - H x W x D: 26.5" x 25" x 21.5" - 675 mm x 635 mm x 550 mm

Model	Weight	Motor	RPM	Start	Run	Setback	Angle	Output
V20-ES	82 lbs 37 kg	Bluffton, single speed, 1 HP, 50/60Hz, 115/230V AC	1,758	4,000 w 15-amp circuit	1,500 w	9 ft 2.7 m	10°	9,007 cfm 15,302 cmh
V20-EX	92 lbs 42 kg	Bluffton, single speed – hazardous location rated for Class 1 Group D, 1 HP, 50/60Hz, 115/230V AC	1,758	4,000 w 15-amp circuit	1,500 w	9 ft 2.7 m	10°	9,007 cfm 15,302 cmh
V20-EV	86 lbs 39 kg	RAE, TEAO variable speed, 1.5 HP 50/60Hz, 115/230V AC	3,131	2,000 w 15-amp circuit	1,500 w	9 ft 2.7 m	11°	13,788 cfm 23,426 cmh





8

**5-YEAR  
WARRANTY**



## 7 SERIES

Featuring a durable steel-frame, roll-cage design with 4-position tilt, the 7 Series PPV has proven itself for decades as a fire department favorite.

- 1 **Full Roll-Cage Frame:** Protects key components
- 2 **4-Position Tilt Frame with Lever:** Provides -10°, 0°, 10°, 20°
- 3 **Fold-Down Ergonomic Handle:** Folds down into frame for compact storage; features full-width handle for easy grip with heavy-duty gloves
- 4 **Flat-Proof Rubber Tires:** Eliminates flat tires; rolls up stairs/curbs easily
- 5 **Single-Piece Cast Aluminum Blade:** Holds up better than plastic in high heat
- 6 **Precision-Spun Steel Shroud:** Provides durability with max airflow
- 7 **Air Cone Guard:** Classic design for maximum airflow; StreamShaper Guard optional
- 8 **Optional Chevron Decal:** Improves visibility of fan by adding a reflective Chevron Decal, available in NFPA 1901 red/yellow and red/white
- 9 **Optional 10' Exhaust Extension and Heat Shield:** Removes emissions away from gas engine or PPV intake; shield slips over extension to prevent metal hose burns

### 16" Blades - H x W x D: 20" x 20.5" x 16" - 510 mm x 520 mm x 410 mm

Model	Weight	Motor	RPM	Start	Run	Setback	Angle	Output
716-E2	68 lbs 31 kg	Bluffton, single speed, 1 HP, 50/60Hz, 115/230V	1,750	4,000 w 15-amp circuit	1,500 w	6 ft 1.8 m	18°	5,890 cfm 10,007 cmh
716-EXP	78 lbs 35.5 kg	Bluffton, single speed – hazardous location rated for Class 1 Group D, 1 HP, 50/60Hz, 115/230V AC	1,750	4,000 w 15-amp circuit	1,500 w	6 ft 1.8 m	18°	5,890 cfm 10,007 cmh
716-EVS	72 lbs 33 kg	RAE, TEAO, variable speed, 1.5 HP, 50/60Hz, 115/230V AC	2,400	2,000 w 15-amp circuit	1,500 w	6 ft 1.8 m	18°	9,950 cfm 16,900 cmh

### 18" Blades - H x W x D: 22" x 23.5" x 19.5" - 560 mm x 600 mm x 500 mm

Model	Weight	Motor	RPM	Start	Run	Setback	Angle	Output
718-E2	82 lbs 37 kg	Bluffton, single speed, 1 HP, 50/60Hz, 115/230V	1,750	4,000 w 15-amp circuit	1,500 w	6 ft 1.8 m	18°	6,378 cfm 10,836 cmh
718-EXP	92 lbs 42 kg	Bluffton, single speed – hazardous location rated for Class 1 Group D, 1 HP, 50/60Hz, 115/230V AC	1,750	4,000 w 15-amp circuit	1,500 w	6 ft 1.8 m	18°	6,378 cfm 10,836 cmh
718-EVS	86 lbs 39 kg	RAE, TEAO, variable speed, 1.5 HP, 50/60Hz, 115/230V AC	2,400	2,000 w 15-amp circuit	1,500 w	6 ft 1.8 m	18°	10,744 cfm 18,254 cmh

### 20" Blades - H x W x D: 25.5" x 26" x 19.5" - 650 mm x 660 mm x 500 mm

Model	Weight	Motor	RPM	Start	Run	Setback	Angle	Output
720-E2	88 lbs 40 kg	Bluffton, single speed, 1 HP, 50/60Hz, 115/230V	1,750	4,000 w 15-amp circuit	1,500 w	6 ft 1.8 m	18°	9,007 cfm 15,302 cmh
720-EXP	98 lbs 45 kg	Bluffton, single speed – hazardous location rated for Class 1 Group D, 1 HP, 50/60Hz, 115/230V AC	1,750	4,000 w 15-amp circuit	1,500 w	6 ft 1.8 m	18°	9,007 cfm 15,302 cmh
720-EVS	92 lbs 42 kg	RAE, TEAO, variable speed, 1.5 HP, 50/60Hz, 115/230V AC	2,400	2,000 w 15-amp circuit	1,500 w	6 ft 1.8 m	18°	13,788 cfm 23,426 cmh

### 24" Blades - H x W x D: 28" x 29.5" x 21" - 710 mm x 750 mm x 535 mm

Model	Weight	Motor	RPM	Start	Run	Setback	Angle	Output
724-E2	104 lbs 47.5 kg	Bluffton, single speed, 1 HP, 50/60Hz, 115/230V	1,750	4,000 w 15-amp circuit	1,500 w	6 ft 1.8 m	18°	13,320 cfm 22,630 cmh
724-EXP	114 lbs 52 kg	Bluffton, single speed – hazardous location rated for Class 1 Group D, 1 HP, 50/60Hz, 115/230V AC	1,750	4,000 w 15-amp circuit	1,500 w	6 ft 1.8 m	18°	13,320 cfm 22,630 cmh
724-EVS	108 lbs 49 kg	RAE, TEAO, variable speed, 1.5 HP, 50/60Hz, 115/230V AC	2,400	2,000 w 15-amp circuit	1,500 w	6 ft 1.8 m	18°	16,370 cfm 27,815 cmh

\*RPM is at 60Hz – for 50Hz – RPM and output should be multiplied by 5/6; TEAO = Totally Enclosed Air Over

## VALOR

The Valor Series is among the latest in Super Vac PPV innovations. Featuring an intuitive frame design that is easy to position on the fireground, the Valor is engineered to ease the toughest ventilation challenges.

### 18" Blades - H x W x D: 23.5" x 22" x 21" - 600 mm x 560 mm x 535 mm

Model	Weight	Engine	Displacement	RPM	Setback	Angle	Output
V18-GX	84 lbs 38 kg	Honda GX200	196 cc	3,535	6 ft 1.8 m	14°	15,168 cfm 25,770 cmh

### 20" Blades - H x W x D: 26.5" x 25" x 21.5" - 675 mm x 635 mm x 550 mm

Model	Weight	Engine	Displacement	RPM	Setback	Angle	Output
V20-GX	86 lbs 39 kg	Honda GX200	196 cc	3,350	6 ft 1.8 m	12°	18,182 cfm 30,891 cmh
V20-GB	86 lbs 39 kg	Vanguard by Briggs & Stratton	205 cc	3,300	6 ft 1.8 m	12°	17,064 cfm 28,991 cmh

- 1 Full Roll-Cage Frame:** Features a tough, tubular aluminum frame to protect key components; delivers a lightweight design (15% lighter than steel frames)
- 2 7-Position Tilt Frame with Step Pad:** Provides 18°, 12°, 6°, 0°, -6°, -12° and -18° angles; allows for fan placement on stairs
- 3 Fold-Down Ergonomic Handle:** Folds down into frame for compact storage; features full-width handle for easy grip with heavy-duty gloves
- 4 Flat-Proof Rubber Tires:** Eliminates flat tires; rolls up stairs and curbs easily; tires are placed on the back of the frame so that firefighters never have to put themselves between the PPV and the fire during setup
- 5 Single-Piece Cast Aluminum Blade:** Holds up better than plastic in high heat
- 6 Precision-Spun Steel Shroud:** Provides durability with max airflow
- 7 StreamShaper Guard:** Standard guard, designed for farther setback; Air Cone Guard available by request
- 8 AMCA-Certified Airflow:** Super Vac is proud to enlist AMCA (the Air Movement and Control Association) as an independent organization to conduct third-party performance tests.



**5-YEAR  
WARRANTY**



# 7 SERIES

Featuring a durable steel-frame, roll-cage design with 4-position tilt, this PPV has proven itself for decades.

## 16" Blades - H x W x D: 20" x 20.5" x 16" - 510 mm x 520 mm x 410 mm

Model	Weight	Engine	Displacement	RPM	Setback	Angle	Output
716G4-H	74 lbs 34 kg	Honda GX120	118 cc	3,530	6 ft 1.8 m	18°	11,740 cfm 19,945 cmh
716G4-B	68 lbs 31 kg	Vanguard by Briggs & Stratton	127 cc	3,450	6 ft 1.8 m	18°	9,940 cfm 16,890 cmh

## 18" Blades - H x W x D: 22" x 23.5" x 19.5" - 560 mm x 600 mm x 500 mm

Model	Weight	Engine	Displacement	RPM	Setback	Angle	Output
718G4-H	86 lbs 39 kg	Honda GX200	196 cc	3,535	6 ft 1.8 m	18°	15,168 cfm 25,770 cmh
718G4-B	84 lbs 38 kg	Vanguard by Briggs & Stratton	205 cc	3,770	6 ft 1.8 m	18°	14,860 cfm 25,247 cmh

## 20" Blades - H x W x D: 25.5" x 26" x 19.5" - 650 mm x 660 mm x 500 mm

Model	Weight	Engine	Displacement	RPM	Setback	Angle	Output
720G4-H	96 lbs 44 kg	Honda GX200	196 cc	3,350	6 ft 1.8 m	18°	18,182 cfm 30,891 cmh
720G4-B	94 lbs 43 kg	Vanguard by Briggs & Stratton	205 cc	3,385	6 ft 1.8 m	18°	17,235 cfm 29,282 cmh

## 24" Blades - H x W x D: 28" x 29.5" x 21" - 710 mm x 750 mm x 535 mm

Model	Weight	Engine	Displacement	RPM	Setback	Angle	Output
724G4-H	134 lbs 61 kg	Honda GX270	270 cc	3,435	6 ft 1.8 m	18°	20,920 cfm 35,545 cmh
724G4-B	120 lbs 55 kg	Vanguard by Briggs & Stratton	306 cc	3,245	6 ft 1.8 m	18°	21,100 cfm 35,850 cmh

## 30" Blade - H x W x D: 39" x 37" x 27.5" - 990 mm x 940 mm x 700 mm

Model	Weight	Engine	Displacement	RPM	Setback	Angle	Output
730G4-H	163 lbs 74 kg	Honda GX390	389 cc	3,220	6 ft 1.8 m	10°	26,849 cfm 45,616 cmh

- 1 Full Roll-Cage Frame:** Protects key components
- 2 4-Position Tilt Frame with Lever:** Provides -10°, 0°, 10°, 20°
- 3 Flat-Proof Rubber Tires:** Eliminates flat tires; rolls up stairs/curbs easily
- 4 Single-Piece Cast Aluminum Blade:** Holds up better than plastic in high heat
- 5 Precision-Spun Steel Shroud:** Provides durability with max airflow
- 6 Air Cone Guard:** Creates maximum airflow; StreamShaper Guard optional

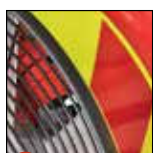

- 7 Optional Chevron Decal:** Improves visibility of fan by adding reflective decal, available in NFPA 1901 red/yellow and red/white
- 8 Optional 10' Exhaust Extension and Heat Shield:** Removes emissions away from gas engine or PPV intake; shield slips over extension to prevent metal hose burns



# WATER TURBINE PPVs

## WT SERIES

Water turbine motors power these positive pressure ventilation fans. These units run without the use of electricity or gasoline, making them great in explosive locations with unknown gases.

**5-YEAR WARRANTY**



- 1 **4-Position Tilt Frame with Step Brake:** Provides -10°, 0°, 10°, 20°
- 2 **Cast Aluminum Blade:** Holds up better than plastic in high heat
- 3 **Air Cone Guard:** Provides max airflow; StreamShaper Guard optional

**16" Blades - H x W x D: 20" x 20.5" x 16" - 510 mm x 520 mm x 405 mm**

Model	Weight	Power	Consumption	Output
716WT	70 lbs 32 kg	5.5 HP water turbine 100-250psi	65 gpm	12,900 cfm 21,920 cmh

## CONFINED SPACE

## F SERIES

Super Vac's F Series confined space ventilators provide unmatched durability. The entire frame is constructed of steel, and the patented 4-tip recurve aluminum blade is precision balanced for maximum output. Available motors: single speed, single high speed, variable speed and pneumatic.

**5-YEAR WARRANTY**

- 1 **Patented 4-Tip Recurved Aluminum Blade:** Creates a tight spiral of air to eject smoke and fumes away from the building; aluminum holds up better than plastic in high heat
- 2 **Precision-Balanced Blade:** Maximizes output
- 3 **Heavy-Duty Rubber Feet:** Friction keeps fan in place
- 4 **4 Carry Handles:** Makes transportation easy with one or two people
- 5 **Front and Rear Guards:** Prevents accidental contact with key components

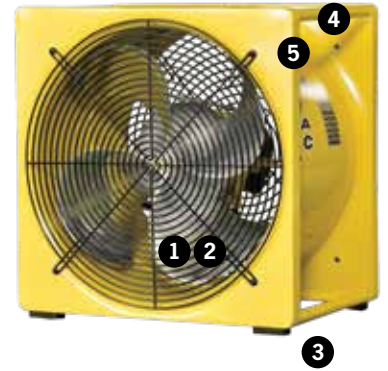

**12" Blades - H x W x D: 15.5" x 15" x 13" - 395 mm x 380 mm x 330 mm \*AF and VF models add 5" (127 mm) to Height**

Model	Weight	Motor	RPM	Start	Run	Output
F124	40 lbs 18 kg	Bluffton, single speed, TEAO, 1/3 HP, 50/60Hz, 115/230V AC	1,725	2,000 w 15-amp circuit	800 w	2,100 cfm 3,570 cmh
HF124	40 lbs 18 kg	Bluffton, single speed, TEAO, 1/2 HP, 50/60Hz, 115/230V AC	3,450	2,000 w 15-amp circuit	800 w	3,700 cfm 6,285 cmh
F124E	42 lbs 19 kg	Bluffton, single speed, hazardous location rated for Class 1 Group D, 1/3 HP, 50/60Hz, 115/230V AC	1,725	2,000 w 15-amp circuit	800 w	2,100 cfm 3,570 cmh
HF124E	42 lbs 19 kg	Bluffton, single speed, hazardous location rated for Class 1 Group D, 1/2 HP, 50/60Hz, 115/230V AC	3,450	2,000 w 15-amp circuit	800 w	3,700 cfm 6,285 cmh
VF124	40 lbs 18 kg	RAE, TEAO variable speed, 1 HP 50/60Hz, 115/230V AC	2,500	2,000 w 15-amp circuit	800 w	3,100 cfm 5,265 cmh
AF124	39 lbs 18 kg	Pneumatic, 1/2 HP	2,000	80 PSI - 27 cfm		3,800 cfm 6,455 cmh

**16" Blades - H x W x D: 19.25" x 18.75" x 13" - 490 mm x 480 mm x 330 mm \*AF and VF models add 5" (127 mm) to Height**

Model	Weight	Motor	RPM	Start	Run	Output
F164	44 lbs 20 kg	Bluffton, single speed, TEAO, 1/3 HP, 50/60Hz, 115/230V AC	1,725	2,000 w 15-amp circuit	700 w	5,200 cfm 8,835 cmh
HF164	59 lbs 27 kg	Bluffton, single speed, TEAO, 1-1/2 HP, 50/60Hz, 115/230V AC	3,450	6,000 w 20-amp circuit	2,100 w	9,620 cfm 16,345 cmh
F164E	49 lbs 22 kg	Bluffton, single speed, hazardous location rated for Class 1 Group D, 1/3 HP, 50/60Hz, 115/230V AC	1,725	2,000 w 15-amp circuit	700 w	5,200 cfm 8,835 cmh
HF164E	63 lbs 28.5 kg	Bluffton, single speed, hazardous location rated for Class 1 Group D, 1-1/2 HP, 50/60Hz, 115/230V AC	3,450	6,000 w 20-amp circuit	2,100 w	9,620 cfm 16,345 cmh
VF164	52 lbs 23.5 kg	RAE, TEAO variable speed, 1 HP 50/60Hz, 115/230V AC	2,500	2,000 w 15-amp circuit	800 w	5,900 cfm 10,025 cmh
AF164	45 lbs 20.5 kg	Pneumatic, 1-1/2 HP	3,600	100 PSI - 75 cfm		9,600 cfm 16,310 cmh

### 18" Blades - H x W x D: 21.75" x 22.5" x 18.75" - 555 mm x 575 mm x 480 mm

Model	Weight	Power	Consumption	Output
718WT	76 lbs 34.5kg	5.5 HP water turbine 100-250psi	65 gpm	16,830 cfm 28,595 cmh

### 20" Blades - H x W x D: 25.5" x 25.5" x 18.75" - 650 mm x 650 mm x 480 mm

Model	Weight	Power	Consumption	Output
720WT	78 lbs 35.5 kg	5.5 HP water turbine 100-250psi	65 gpm	19,650 cfm 33,385 cmh

### 24" Blades - H x W x D: 27.75" x 29" x 21" - 705 mm x 740 mm x 535 mm

Model	Weight	Power	Consumption	Output
724WT	88 lbs 40 kg	12 HP water turbine 100-250 psi	130 gpm	22,470 cfm 38,175 cmh

### 30" Blades - H x W x D: 39" x 37" x 27.5" - 990 mm x 940 mm x 700 mm

Model	Weight	Power	Consumption	Output
730WT	102 lbs 46.5 kg	12 HP water turbine 100-250 psi	130 gpm	24,800 cfm 42,135 cmh

### 20" Blades - H x W x D: 25.5" x 24.75" x 16.25" - 650 mm x 630 mm x 415 mm \*AF and VF models add 5" (127 mm) to height

Model	Weight	Motor	RPM	Start	Run	Output
F200	85 lbs 38.5 kg	Bluffton, single speed, TEAO, 1 HP, 50/60Hz, 115/230V AC	1,725	4,000 w 15-amp circuit	1,500 w	9,500 cfm 16,140 cmh
F200E	93 lbs 42 kg	Bluffton, single speed, hazardous location rated for Class 1 Group D, 1 HP, 50/60Hz, 115/230V AC	1,725	4,000 w 15-amp circuit	1,500 w	9,500 cfm 16,140 cmh
VF200	88 lbs 40 kg	RAE, TEAO variable speed, 1 HP 50/60Hz, 115/230V AC	2,500	2,000 w 15-amp circuit	800 w	9,800 cfm 16,650 cmh
AF200	60 lbs 27 kg	Pneumatic, 1-1/2 HP	3,600	100 PSI - 75 cfm		9,800 cfm 16,650 cmh

### 24" Blades - H x W x D: 28.5" x 28" x 18.75" - 725 mm x 710 mm x 480 mm \*AF model adds 5" (127 mm) to height

Model	Weight	Motor	RPM	Start	Run	Output
F244	110 lbs 50 kg	Bluffton, single speed, TEAO, 1-1/2 HP, 50/60Hz, 115/230V AC	1,725	6,000 w 20-amp circuit	2,100 w	11,800 cfm 20,050 cmh
F244E	115 lbs 52 kg	Bluffton, single speed, hazardous location rated for Class 1 Group D, 1-1/2 HP, 50/60Hz, 115/230V AC	1,725	6,000 w 20-amp circuit	2,100 w	11,800 cfm 20,050 cmh
AF244	105 lbs 48 kg	Pneumatic, 5 HP	2,250	100 PSI - 100 cfm		14,200 cfm 24,125 cmh

## NANO

The market's smallest, most powerful confined space fan!

- 1 Versatile:** Can be used for positive or negative pressure operations; the duct can be attached to either end
- 2 Carry Handles:** Provides easy transport



**5-YEAR WARRANTY**

### 8" Blades - H x W x D: 11.5" x 10.75" x 16" - 295 mm x 275 mm x 406 mm

Model	Weight	Motor	Output	Nano Pacs
P8S	20 lbs 9 kg	1/3 HP, TEAO (Totally Enclosed Air Over), 60Hz, 115V AC	1,054 cfm 1,790 cmh	Available as kit with 15' or 25' standard duct
P8XE	22 lbs 10 kg	1/3 HP, hazardous location rated for Class 1 Group D, 60Hz, 115V AC	1,054 cfm 1,790 cmh	Available as kit with 15' or 25' conductive duct

\* Available in 50Hz, 220V by adding "-220" to model number; available in 12V DC by adding "-12V" to model number

**See Page 21 for confined space ducts.**

# SMOKE EJECTORS

## BATTERY **NEW**

The **ALL-NEW** Super Vac 16" battery-powered Smoke Ejector is designed to work with your current battery-powered rescue tools and is compatible with DeWalt®, Milwaukee® or Makita® battery platforms.

- Compatible Batteries:** DeWalt FLEXVOLT, Milwaukee REDLITHIUM and Makita XGT batteries
- Compact, Roll-Cage Frame:** Features a tough yet lightweight frame to protect the fan's key components
- Optional Shore Power:** Provides continuous use
- StreamShaper Guard:** Allows for flexible setback

- Dual Inlet or Outlet:** Maximizes ventilation versatility
- (2) Carry Handles:** Makes transportation easy with one or two people
- Polymer Blade:** Minimizes weight; Super Vac's single-piece cast aluminum blade is available by request
- Heavy-Duty Rubber Feet:** Adds friction to keep fan in place and steady

**5-YEAR WARRANTY**

### 16" Blades - H x W x D: 25.5" x 18.875" x 9.75" - 650 mm x 480 mm x 250 mm

Models	Weight Without Batteries	Motor	Runtime at Max Airflow	Setback For Output Rating	Output
P164-BD (DeWalt FLEXVOLT)***	38 lbs 17.3 kg	Totally Enclosed Variable-Speed DC	9.0Ah (2) - 33 minutes 12.0Ah (2) - 44 minutes 15.0Ah (2) - 56 minutes	14 ft 4.3 m	6,700 cfm 11,380 cmh
P164-BK (Makita XGT)	38 lbs 17.3 kg	Totally Enclosed Variable-Speed DC	4.0Ah (2) - 26 minutes 5.0Ah (2) - 34 minutes 8.0Ah (2) - 52 minutes	14 ft 4.3 m	6,700 cfm 11,380 cmh
P164-BL (Milwaukee M18)	38 lbs 17.3 kg	Totally Enclosed Variable-Speed DC	XC 8.0Ah (2) - 40 minutes HD 12.0Ah (2) - 58 minutes	14 ft 4.3 m	6,700 cfm 11,380 cmh
P164-BW (Milwaukee M28)**	38 lbs 17.3 kg	Totally Enclosed Variable-Speed DC	XC 3.0Ah (2) - 30 minutes XC 5.0Ah (2) - 50 minutes	14 ft 4.3 m	6,700 cfm 11,380 cmh

\*\*For M28 batteries or chargers, please see your Genesis, TNT or Weber dealer.

\*\*\*DeWalt batteries required in pairs. Use only batteries' proprietary charging equipment to charge batteries.



## ELECTRIC

This box-shaped fan pulls smoke from a structure using negative pressure but can be flipped around for positive pressure tactics.

- Patented 4-Tip Recurved Aluminum Blade:** Creates a tight spiral of air to eject smoke and fumes away from the building
- Precision-Balanced Blade:** Maximizes output
- Heavy-Duty Rubber Feet:** Adds friction to keep fan in place
- 4 Carry Handles:** Makes transportation easy with one or two people
- Front and Rear Guards:** Prevents accidental contact with key components

**5-YEAR WARRANTY**

### 12" Blades - H x W x D: 15.5" x 15" x 13" - 395 mm x 380 mm x 330 mm

Model	Weight	Motor	RPM	Start	Run	Output
P124S	40 lbs 18 kg	Bluffton, single speed, TEAO, 1/2 HP, 50/60Hz, 115/230V AC	3,450	2,000 w 15-amp circuit	800 w	3,700 cfm 6,285 cmh
P124SE	42 lbs 19 kg	Bluffton, single speed, hazardous location rated for Class 1 Group D, 1/2 HP, 50/60Hz, 115/230V	3,450	2000 w 15-amp circuit	800 w	3,700 cfm 6,285 cmh

### 16" Blades - H x W x D: 19.25" x 18.75" x 13" - 490 mm x 480 mm x 330 mm

Model	Weight	Motor	RPM	Start	Run	Output
P164S	44 lbs 20 kg	Bluffton, single speed, TEAO, 1/3 HP, 50/60Hz, 115/230V AC	1,725	2,000 w 15-amp circuit	700 w	5,200 cfm 8,835 cmh
P164S-AL	40 lbs 18 kg	Bluffton, single speed, TEAO, 1/3 HP, 50/60Hz, 115/230V AC. Aluminum Frame Design (vs. Steel)	1,725	2,000 w 15-amp circuit	700 w	5,200 cfm 8,835 cmh
P164SE	49 lbs 22 kg	Bluffton, single speed, hazardous location rated for Class 1 Group D, 1/3 HP, 50/60Hz, 115/230V AC	1,725	2,000 w 15-amp circuit	700 w	5,200 cfm 8,835 cmh
P164SE-AL	45 lbs 21 kg	Bluffton, single speed, hazardous location rated for Class 1 Group D, 1/3 HP, 50/60Hz, 115/230V AC - Aluminum Frame Design (vs. Steel)	1,725	2,000 w 15-amp circuit	700 w	5,200 cfm 8,835 cmh

### 20" Blades - H x W x D: 25.5" x 24.75" x 16.25" - 650 mm x 630 mm x 415 mm

Model	Weight	Motor	RPM	Start	Run	Output
P200S	85 lbs 38.5 kg	Bluffton, single speed, TEAO, 1 HP, 50/60Hz, 115/230V AC	1,725	4,000 w 15-amp circuit	1,500 w	9,800 cfm 16,650 cmh
P200S-AL	70 lbs 32 kg	Bluffton, single speed, TEAO, 1 HP, 50/60Hz, 115/230V AC - Aluminum Frame Design (vs. Steel)	1,725	4,000 w 15-amp circuit	1,500 w	9,800 cfm 16,650 cmh
P200SE	93 lbs 42 kg	Bluffton, single speed, hazardous location rated for Class 1 Group D, 1 HP, 50/60Hz, 115/230V AC	1,725	4,000 w 15-amp circuit	1,500 w	9,800 cfm 16,650 cmh
P200SE-AL	78 lbs 36 kg	Bluffton, single speed, hazardous location rated for Class 1 Group D, 1 HP, 50/60Hz, 115/230V AC - Aluminum Frame Design (vs. Steel)	1,725	4,000 w 15-amp circuit	1,500 w	9,800 cfm 16,650 cmh

### 24" Blades - H x W x D: 28.5" x 28" x 18.75" - 725 mm x 710 mm x 480 mm

Model	Weight	Motor	RPM	Start	Run	Output
P244S	110 lbs 50 kg	Bluffton, single speed, TEAO, 1-1/2 HP, 50/60Hz, 115/230V AC	1,725	6,000 w 20-amp circuit	2,100 w	11,800 cfm 20,050 cmh
P244SE	115 lbs 52 kg	Bluffton, single speed, hazardous locatio rated for Class 1 Group D, 1-1/2 HP, 50/60Hz, 115/230V AC	1,725	6,000 w 20-amp circuit	2,100 w	11,800 cfm 20,050 cmh



# GAS

Among the smallest gas-powered fans in the industry, the 16" and 18" Super Vac Smoke Ejectors can fit into tight compartments and yet pack a cfm output that matches larger electrical smoke ejectors thanks to the powerful Honda GX engine.

- 1 **Single-Piece Cast Aluminum Blade:** For superior strength, durability, and temperature resistance.
- 2 **Precision-Balanced Blade:** Maximizes output
- 3 **Heavy-Duty Rubber Feet:** Adds friction to keep fan in place
- 4 **4 Carry Handles:** Makes transportation easy with one or two people
- 5 **Front and Rear Guards:** Prevents accidental contact with key components



**5-YEAR WARRANTY**

## 16" Blade - H x W x D: 19.5" x 19" x 15.5" - 495 mm x 485 mm x 395 mm

Model	Weight	Engine	Displacement	RPM	Output
GP164S	55 lbs 25 kg	Honda GX120	118 cc	3,500	9,250 cfm 15,715 cmh
GP167S	58 lbs 27 kg	Honda GX160	163 cc	3,500	9,500 cfm 16,140 cmh

## 18" Blade - H x W x D: 23.5" x 23" x 16.5" - 600 mm x 585 mm x 420 mm

Model	Weight	Engine	Displacement	RPM	Output
GP187S	76 lbs 34 kg	Honda GX200	196 cc	3,500	10,551 cfm 17,926 cmh

# WT SERIES

Powered by water turbine motors, this Smoke Ejector runs without the use of electricity or gasoline, making it great in explosive locations with unknown gases.

- 1 **Single-Piece Cast Aluminum Blade:** For superior strength, durability, and temperature resistance.
- 2 **Precision-Balanced Blade:** Maximizes output
- 3 **Fitting Sizes:** Standard with 1.5" NHT hose fitting; other sizes available as option
- 4 **Heavy-Duty Rubber Feet:** Adds friction to keep fan in place
- 5 **4 Carry Handles:** Makes transportation easy with one or two people
- 6 **Front and Rear Guards:** Prevents accidental contact with key components



**5-YEAR WARRANTY**

## 12" Blades - H x W x D: 15.5" x 15" x 13" - 395 mm x 380 mm x 330 mm

Model	Weight	Power	Consumption	Output
P124WT	50 lbs 23 kg	5.5 HP Water Turbine - 100 - 250 PSI	65 gpm	4,300 cfm 7,305 cmh

## 16" Blades - H x W x D: 19.25" x 18.75" x 13" - 490 mm x 480 mm x 330 mm

Model	Weight	Power	Consumption	Output
P164WT	57 lbs 26 kg	5.5 HP Water Turbine - 100 - 250 PSI	65 gpm	9,950 cfm 16,905 cmh

## 20" Blades - H x W x D: 25.5" x 24.75" x 16.25" - 650 mm x 630 mm x 415 mm

Model	Weight	Power	Consumption	Output
P200WT	88 lbs 40 kg	5.5 HP Water Turbine - 100 - 250 PSI	65 gpm	10,800 cfm 18,350 cmh

## 24" Blades - H x W x D: 28.5" x 28" x 18.75" - 725 mm x 710 mm x 480 mm

Model	Weight	Power	Consumption	Output
P244WT	123 lbs 56 kg	5.5 HP Water Turbine - 100 - 250 PSI	65 gpm	14,200 cfm 24,125 cmh

# LARGE-SCALE



See this product in action at [bit.ly/svu-operation](http://bit.ly/svu-operation)

**1-YEAR  
WARRANTY**



## SVU

The SVU is the most versatile, large-scale positive pressure ventilator in the industry. With a wide array of configurations, this PPV is perfect for ventilating airport terminals, large warehouses, commercial structures, high-rise buildings and mass rehabilitation areas.

- 1 6-Point Carbon Fiber Blade:**  
48" (1,219 mm) in diameter
- 2 Choice of Direct-Drive Engine:**
  - ◊ Kubota 3.8L Gasoline Engine  
Performance: 87 HP (65kw)  
Fuel Consumption: 8 gph (30 L/hr)  
Fuel Tank Capacity: 18 g (68 L)
  - ◊ Cummins 3.8L Diesel Engine  
Performance: 132 HP (99 kw)  
Fuel Consumption: 7.4 gph (28 L/hr)  
Fuel Tank Capacity: 18 g (68 L)



**3 Rotate, Raise and Tilt:** The Electric Turntable rotates the fan up to 270°; the Scissor Lift extends the SVU up to 30' in the air and tilts 20° up and down



**4 Mounting Options:** Choose from Skid Unit, Custom Trailer, Truck or Flatbed



**5 Optional Accessories:** Misting Ring provides 30 GPM at 60 psi, while optional ducting and LED lights add even more versatility



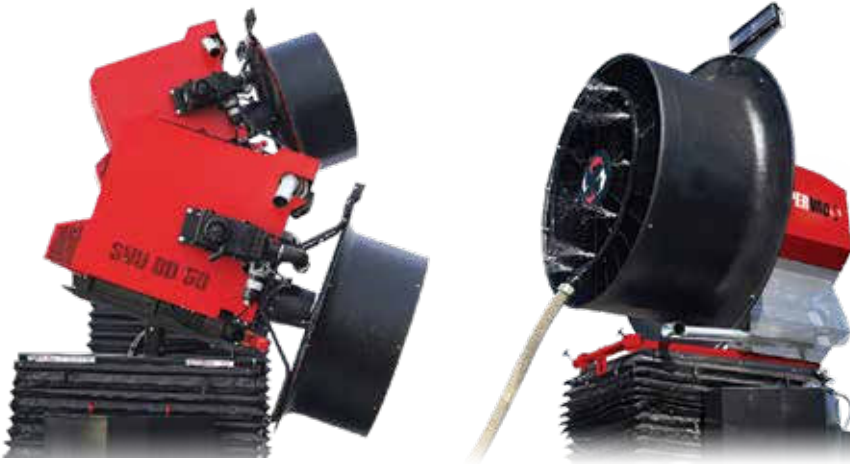

Cummins 3.8L Diesel Engine

Kubota 3.8L Gas Engine

**Diesel Powered** - H x W x D: 82" x 70" x 42" - 2,090 mm x 1,780 mm x 1,070 mm

Model	Weight*	Engine	Displacement	RPM	Output
SVU-DD-50	1,850 lbs 839 kg	Cummins 3.8L Diesel	3.8L	2,450	200,000 cfm 339,800 cmh

\* Without trailer

**Gas Powered** - H x W x D: 70" x 70" x 42" - 1,780 mm x 1,780 mm x 2,720 mm

Model	Weight*	Engine	Displacement	RPM	Output
SVU-50	1,540 lbs 703 kg	Kubota 3.8L Gas	3.5L	2,600	200,000 cfm 339,800 cmh

\* Without trailer

**6 Reduce Manufacturing Downtime During a Ventilation Emergency:**  
Downtime can adversely affect a facility, costing a company \$2,500-\$5,000 per inoperable minute, or upwards of:

- \$5,000 per minute
  - \$300,000 per hour
  - \$2.4 million per day
- This large industrial fan produces a 200,000 cfm output to ventilate large structures in a fraction of the time.



See this product in action at [bit.ly/oklahoma-city-SVU-1220](http://bit.ly/oklahoma-city-SVU-1220)

# SVU MOBILE VENTILATION VEHICLE

The Super Vac SVU is mounted on a Ford F-450 4x2 single-door flatbed chassis, making this mobile unit perfect for ventilating airport terminals, manufacturing facilities, large warehouses, commercial structures and high-rise buildings.

- 1 6-Point, 48" Diameter Carbon Fiber Blade:**  
Produces 200,000 cfm
- 2 Kubota 3.8 Direct-Drive Gas Engine:**
  - Performance: 87 HP (65kw)
  - Fuel Consumption: 8 gph (30L/hr)
  - Fuel Tank Capacity: 18 g (68 L)
- 3 Electric Turntable:**  
Rotates fan up to 270 degrees
- 4 Scissor Lift:**  
Allows for +/- 20-degree up-and-down tilt
- 5 Opposing Fold-Down Side Doors:**  
Provides access to additional storage, allowing roll-down access for additional fans or equipment
- 6 Ford F-450 4x2 flatbed chassis:**  
Turns the SVU into a mobile unit
- 7 Onan Protec PTO Generator:**  
Adds 15,000-watts of surplus energy to power additional fans, lighting or equipment



## UNMANNED MISTING TURBINES



Learn more about these robotic fans and see them in action at [bit.ly/unmanned-turbines](http://bit.ly/unmanned-turbines)



Introducing Super Vac's large industrial fan by EmiControls with water mist system, which atomizes water and extinguishing foam into a fine mist before propelling up to 300 feet with Quadrijet nozzles and turbine propeller. EmiControls advanced remote control adds another 1,000 feet of distance from the hazard, making these turbines the most ultimate unmanned firefighting fans on the market.



## SPECIALTY AIRCRAFT BRAKE COOLING FAN

Super Vac's Brake Cooling Fan is a specialized unit designed to pull air over the brakes of commercial aircraft, allowing for quicker turnover for airports with long taxies and hot weather.

Model	Weight	Motor/Engine
724BCS	108 lbs 49 kg	1 HP TEAO Motor
724BCV	105 lbs 48 kg	1.5 HP Variable Speed Motor
724BCX	110 lbs 50 kg	1.5 HP Hazardous Location Motor
724BCH	103 lbs 47 kg	4 HP Honda Engine
724BCB	86 lbs 39 kg	1 HP, Variable-Speed DC; available with DeWalt, Makita or Milwaukee batteries



TAF60X



MFT35H



TAF35

Model	Type	Output	Throwing Distance	Water Flow
MFT35H	Turntable	35,000 cfm 59,000 cmh	250 ft 75 m	1,000 gpm 3,785 L/min
TAF60X	Mobile	35,000 cfm 59,000 cmh	300 ft 90 m	1,500 gpm 5,678 L/min
TAF35	Mobile	35,000 cfm 59,000 cmh	300 ft 90 m	1,250 gpm 4,732 L/min



# FOAM AND MIST GENERATION



See this product in action  
at [bit.ly/battery-fan-with-foam](http://bit.ly/battery-fan-with-foam)

## HIGH-EXPANSION FOAM GENERATOR

This foam generator attaches easily to any Super Vac PPV (from 16"-30") or Super Vac Smoke Ejector (from 16"-24") and is capable of producing foam up to an expansion rate of 1000:1 for tough extinguishments, including oil and mining operations, ship-hold areas and scenes with flammable liquids.

Model	Pairs With
HXG-PPV	16"-30" PPVs
HXG-E	16"-24" Smoke Ejectors

Includes: Metal shroud, foam expansion netting, a 30 GPM in-line educator and 1 1/2" NH hose adapter. Can be ordered in either red or blue. Please specify fan model when ordering.



Pictured: MM-MAG

## MOUNTAIN MISTER

The Super Vac Mountain Mister can convert any fan into a cooling unit for rehabilitation.

- Mister Compatibility:** Attaches to the outlet guard of any PPV, smoke ejector or blower/exhauster with brackets (Model MM) or industrial magnets (MM-MAG); simply attach a garden hose or an auxiliary line from any fire apparatus pump panel to provide heat relief
- Versatile Design:** Can be used by itself; simply hang under an awning, from a shady tree or over the pump panel
- Water Efficiency:** Only consumes 3 gallons of water per hour!
- Optional Features:** Storz connection and magnetic version for StreamShaper guards

## MISTER FAN

Designed for rehab, the F164M is a 16" single-speed electric fan with three built-in misting nozzles on the discharge side of the fan. As powerful as the Super Vac P164S Smoke Ejector, this fan can double as a smoke ejector.

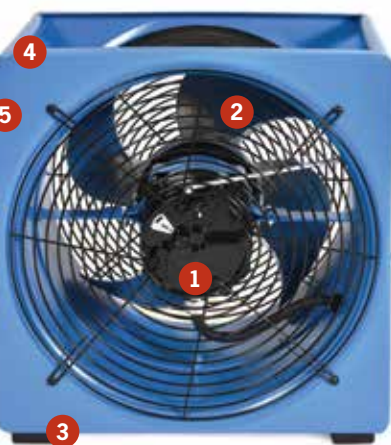

- (3) Built-In Misting Nozzles:** Only requires 2 gallons of water per hour via any garden hose or auxiliary line; design reduces ambient air stream by 30° F; nozzle made of brass, prevents rust
- Patented 4-Tip Recurved Aluminum Blade:** Creates a tight spiral of air to eject smoke and fumes away from the building; aluminum holds up better than plastic in high heat
- Heavy-Duty Rubber Feet:** Adds friction to keep fan in place
- (4) Carry Handles:** Makes transportation easy with one or two people
- Aluminum Frame Design:** Prevents rust, reduces weight

**16" Blades - H x W x D: 19.75" x 18.75" x 13" - 500 mm x 480 mm x 330 mm**

Model	Weight	Motor	RPM	Start	Run	Output
F164M	41 lbs 18.5 kg	Bluffton, single speed, TEAO, 1/3 HP, 50/60Hz, 115/230V	1,725	2,000 w 15-amp circuit	700 w	5,200 cfm 8,835 cmh



Pictured above: MM

Model	Pairs With
MM	Cone Guard PPVs / Smoke Ejectors

Model	Pairs With
MM-MAG	StreamShaper Guards

# SMOKE GENERATION



## SMOKE MACHINES

Choose from the mineral-based Super Vac Cloud 9, capable of quickly producing large amounts of training smoke without leaving a slippery residue, or the glycol-based London Fogger, featuring a lightweight design and 50' remote/extension cord.



### Mineral Oil Based (requires Super Vac Cloud 9 Fluid) - H x W x D: 28" x 28.5" x 20.5" - 710 mm x 725 mm x 520 mm

Model	Weight	Outlets	Power Requirements	Fluid Tank	Fluid Consumption	Output
S-975	132 lbs 60 kg	1	110V AC - 1,400 W	0.67 gal - 2.5 L	.33 gph 1.25 L /hr	2,500 cfm 4,250 cmh
S-985	132 lbs 60 kg	1	230V AC - 1,400 W	0.67 gal - 2.5 L	.33 gph 1.25 L /hr	2,500 cfm 4,250 cmh
S-995	132 lbs 60 kg	2	230V AC - 1,400 W	0.67 gal - 2.5 L	.66 gph 3.79 L /hr	5,000 cfm 8,495 cmh

#### Additional Components:

Oil-Based Fluid 6x.0.6-Gal. Bottles (Model S-900); Oil-Based Fluid 55-Gal. Drum (Model S-905); Gas Regulator (Model S-921); 16" Gas Hose (Model S-925); 100-ft. Remote Control Extension (Model S-939)

### Glycol Based (requires Super Vac London Fogger Fluid) - H x W x D: 10" x 20" x 9" - 255 mm x 510 mm x 230 mm

Model	Weight	Outlets	Power Requirements	Warm-Up Time	Fluid Consumption	Output
S-575	26 lbs 12 kg	1	115V AC - 1,400 W	10 min	35 oz/hr 1,035 ml/hr	1,800 cfm 3,060 cmh
S-585	26 lbs 12 kg	1	230V AC - 1,400 W	10 min	35 oz/hr 1,035 ml/hr	1,800 cfm 3,060 cmh
S-595	26 lbs 12 kg	2	230V AC - 1,400 W	10 min	70 oz/hr 2,070 ml/hr	3,600 cfm 6,115 cmh

#### Additional Components:

GLYCOL-Based Fluid 6x.0.6-Gal. Bottles (Model S-500); Oil-Based Fluid 55-Gal. Drum (Model S-505); 500-ft. Remote Control Extension (Model S-935)

## ADAPTERS SMOKE EJECTORS

### Manhole Adapter



Model	Fan Size	Manhole Size
MA12-24	12" 305 mm	24" 610 mm
MA12-30	12" 305 mm	30" 762 mm
MA16-24	16" 406 mm	24" 610 mm
MA16-30	16" 406 mm	30" 762 mm

These aluminum adapters, available in four sizes, allow utility companies to safely place negative pressure fans over a manhole to pull smoke and toxic fumes from below the surface.

Not for use if manhole is only egress.



### Belt-Cuff Duct Adapter

Model: 12", 16", 18", 20", 24" ADAPTER

The duct adapter attaches to any kind of spiral duct with a belted cuff to a smoke ejector. It simply fits over the edge of the fan and secures with two clasps. Available for 12", 16", 18", 20" and 24" smoke ejectors.

# DUCTS AND ADAPTERS



## SPIRAL DUCTS

### PPVS | CONFINED SPACE | SMOKE EJECTORS

Looking for a traditional spiral duct? You won't find a more durable, long-lasting spiral duct than one from Super Vac's lineup. These ducts are ideal for moving large quantities of air into hard-to-reach places using positive or negative pressure and come with a built-in storage/carry bag for easy transportation. Hot-melt wear strips cover the helix for added durability up to 250° F.

#### Standard Duct

Model	Pairs With	Diameter	Length
8x15BC1	8" Nano	8" (205 mm)	15' (4.6 m)
8x25BC1	8" Nano	8" (205 mm)	25' (7.6 m)
12x20AD	12" F Series/Smoke Ejectors	12" (305 mm)	20' (6.1 m)
12x20BC1	12" PPVs	12" (305 mm)	20' (6.1 m)
16x20AD	16" F Series/Smoke Ejectors	16" (405 mm)	20' (6.1 m)
16x20BC1	16" PPVs	16" (405 mm)	20' (6.1 m)
20x20AD	20" F Series/Smoke Ejectors	20" (510 mm)	20' (6.1 m)
20x20BC1	18" and 20" PPVs	20" (510 mm)	20' (6.1 m)
24x20AD	24" F Series/Smoke Ejectors	24" (610 mm)	20' (6.1 m)
24x20BC1	24" PPVs	24" (610 mm)	20' (6.1 m)

For Duct-Only Belt Cuff (no adapter), models end with BC1

For Duct with Adapter, models end with AD

#### Hazardous Location Duct

Model	Pairs With	Diameter	Length
8x15HZ1	8" Nano	8" (205 mm)	15' (4.6 m)
8x25HZ1	8" Nano	8" (205 mm)	25' (7.6 m)
12x20HZAD	12" F Series/Smoke Ejectors	12" (305 mm)	20' (6.1 m)
12x20HZ1	12" PPVs	12" (305 mm)	20' (6.1 m)
16x20HZAD	16" F Series/Smoke Ejectors	16" (405 mm)	20' (6.1 m)
16x20HZ1	16" PPVs	16" (405 mm)	20' (6.1 m)
20x20HZAD	20" F Series/Smoke Ejectors	20" (510 mm)	20' (6.1 m)
20x20HZ1	18" and 20" PPVs	20" (510 mm)	20' (6.1 m)
24x20HZAD	24" F Series/Smoke Ejectors	24" (610 mm)	20' (6.1 m)
24x20HZ1	24" PPVs	24" (610 mm)	20' (6.1 m)

For Duct-Only Belt Cuff (no adapter), models end with HZ1

For Duct with Adapter, models end with HZAD

## L DUCTS CONFINED SPACE

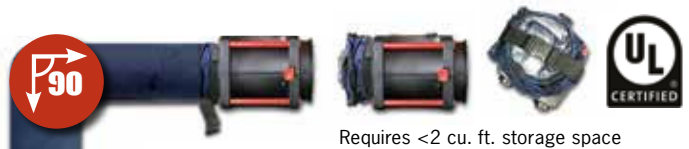

### LFR-BF Duct (for Nano and F Series)

Model	Diameter	Weight	Length
LFR-BF	8" - 205mm (for 8" Nano)	Just 3 lbs.	3' + 8" 0.91 m + 2.44 m

Silver Bullet FR material, made from meta-aramid, ballistic para-aramid and 2% anti-static fiber. Arc resistant and UL certified to NFPA. (Fabric is not conductive or static dissipating.)

Featuring an all-new inherently arc and flame resistant ballistic fabric, Super Vac's Nano Series LFR-BF L-shaped duct delivers one of the safest, most compact hoses. Patent pending!

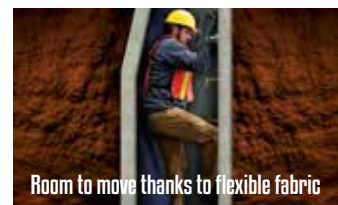
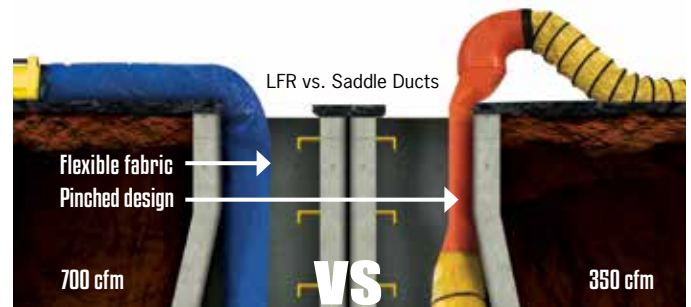

The LFR's unique material allows the vent to contour around the worker while moving through the confined space. The saddle vent helix duct is less forgiving.

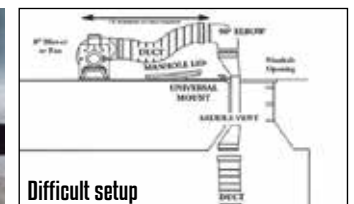

The LFR connects directly to the fan using a built-in strap. Meanwhile, the saddle duct requires setup of multiple components, including manhole lid.



The saddle duct components take up more storage space than the LFR duct.

## ACCESSORIES

### MOUNTING FOR SMOKE EJECTORS

#### Door Bar / Hanger

Model	Pairs With	
HR	All Smoke Ejectors / Battery Fans	
Model	Weight	Usable Range
DOOR BAR	13 lbs 6 kg	26'-60" with extensions

Super Vac's Hanger allows crews to hang a smoke ejector (or battery fan) most anywhere (from ladders, doorways, windows, archways and more). Used with the Door Bar, which deploys easily with a quick-release pull trigger, the fan can be placed at most any height.



#### Tilt Frame

Model	Pairs With	Weight
TF-12	12" Smoke Ejector*	38 lbs 17 kg
TF-16	16" Smoke Ejector*	42 lbs 19 kg

The Tilt Stand Frame is perfect for elevating the fan's airstream (positioned in 18-degree increments for blowing straight up or down). The robust design and wide stance prevents tipping while providing quick setup and effortless tilt. This frame can be built with additional cord length (10' standard).



\*Does not work with gas-powered smoke ejectors.

#### Running Board Mount

Model	Pairs With
RBM-SE	All Smoke Ejectors (Specify fan model when ordering.)

These mounts allow you to carry a Super Vac Smoke Ejector on your vehicle running board for quick access.



### STORAGE

#### WB Bracket

Model	Compatible Pipes
WB Small	For 1.5" (38 mm) Pipe
WB Large	For 2" (50 mm) Pipe

Use Super Vac's WB Brackets with pipe and 2x6s (spaced 5' apart) to create custom storage for hoses, tires and more.

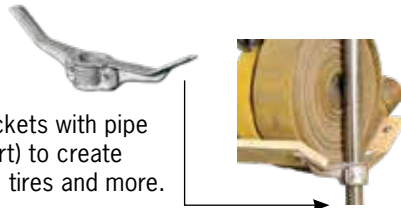

#### Vinyl Cover

Model	Pairs With
VINYL COVER	All PPVs and Smoke Ejectors (Specify fan model when ordering.)

Protect your Super Vac PPV with a vinyl fan cover. Available in red or yellow for all PPVs and Smoke Ejectors up to 30".



### LIGHT KIT

#### 12-Watt Spot/Combo LEDs

This kit adds a 12-watt spot/combo LED to any electric- or Honda GX200-powered PPV. These LEDs are mounted to the fold-down handle.

Model	Pairs With
LIGHT KIT, E PPV	Electric PPVs
LIGHT KIT, H PPV	Honda PPVs

Adds 1/2" (15mm) height to PPV's stowed dimensions



### ENVIRONMENTAL CONTROL

#### Rapid Tent and HeatPac 25

The Rapid Tent deploys in less than 1 minute, providing shelter for long scenes. Units can combine to double space and features a front/rear door. Featuring an 8" blower, the CGA-approved HeatPac25 connects to propane to provide warmth at a temperature rise of 80° F over ambient. The 25' duct delivers 70,000 BTUs of heat for 10 hours.

Model	Stowed / Deployed HxWxD		Space			
RT10X10RD	10" x 10" x 88" / 8.5" x 10' x 10'		100 sq. ft. of floor space + 7.5 ft. of headroom			
Model	Requirements	Height	Width	Depth	Weight	Output
HEATPAC 25	Propane 2 lbs/hour	15.25" 385 mm	33" 840 mm	13.5" 345 mm	50 lbs 23 kg	80° F of temp rise @ 500 cfm (850 chm)



### EXHAUST EXTENSION

#### 10' Extension with optional Heat Shield

Removes emissions away from gas engine or PPV intake; shield slips over extension to prevent metal hose burns.

Model	Pairs With
EXHAUST EXTENSION	Gas PPVs
HEAT SHIELD	Gas PPVs

## BATTERY-POWERED CHAINSAW CONVERSION KIT

**2-YEAR  
COMPONENT  
WARRANTY**

Super Vac's all-new Chain Saw Conversion Kits turn any ordinary 16" or 20" wood-cutting Makita, DeWalt, Milwaukee or Echo battery-powered chainsaw into the perfect overhaul or rapid intervention saw for firefighter operations. These battery-powered saws are usually only ideal for cutting wood, but this kit equips the saw with a carbide tip chainsaw chain capable of cutting through asphalt shingles, hurricane glass, roofing materials and more.\*\*







### Kit Components

- 1 Carbide-Tipped Chain:** Converts select battery-powered chain saws into a rescue saw capable of cutting through wood, nails, asphalt shingles and light metal, as well as residential and commercial roofing; easily sharpens with diamond equipment.
- 2 Modified Bar:** Allows the wider chain gauge to operate with added room, putting less strain on the saw for repeat and heavy use; the bar is slotted to work with Super Vac's Quick Silver depth gauge.
- 3 Optional Quick Silver Depth Gauge:** Prevents the blade from cutting too deep during roof ventilation.

\* 20" only available on DeWalt FLEXVOLT Battery-Powered Chainsaw  
\*\* Heavier construction materials may cause chain wear.



Component	Model	Size	Weight	Battery-Powered Saw Compatibility	Materials
 Chain	SV375-16	16" 405 mm	6.4 oz 182 g	Makita: 18V X2 (36V) LXT Brushless Chainsaw DeWalt: FLEXVOLT DCCS670 Cordless Chainsaw Type 1* Milwaukee: M18 Fuel Cordless Chainsaw Echo: Echo 58V Cordless Chainsaw	Chisel chain; carbide tipped (super grade for better impact resistance); loop for the bar, 3/8 x .050; single-raker design
	SV375-20	20" 410 mm	11 oz 312 g	DeWalt: FLEXVOLT DCCS677 Chainsaw	
 Bar	SV530-16	16" 405 mm	22.3 oz 632 g	Makita: 18V X2 (36V) LXT Brushless Chainsaw DeWalt: FLEXVOLT DCCS670 Cordless Chainsaw Type 1* Milwaukee: M18 Fuel Cordless Chainsaw Echo: Echo 58V Cordless Chainsaw	Flame-hardened rails to 60 Rockwell C; precision-honed groove and replaceable roller nose for smoother operation/longer life
	SV530-20	20" 410 mm	33 oz 936 g	DeWalt: FLEXVOLT DCCS677 Chainsaw	
 Depth Gauge (Optional)	SV780-16	16" 405 mm	15.8 oz 448 g	Makita: 18V X2 (36V) LXT Brushless Chainsaw DeWalt: FLEXVOLT DCCS670 Cordless Chainsaw Type 1* Milwaukee: M18 Fuel Cordless Chainsaw Echo: Echo 58V Cordless Chainsaw	Billet aluminum for lightweight strength; CNC machined for precision; open design prevents clogging of debris Billet aluminum for lightweight strength; CNC machined for precision; open design prevents clogging of debris
	SV780-20	20" 410 mm	15.8 oz 448 g	DeWalt: FLEXVOLT DCCS677 Chainsaw	
 Complete Kit	SV789-16	16" 405 mm	See weights above	Makita: 18V X2 (36V) LXT Brushless Chainsaw DeWalt: FLEXVOLT DCCS670 Cordless Chainsaw Type 1* Milwaukee: M18 Fuel Cordless Chainsaw Echo: Echo 58V Cordless Chainsaw	For the most economical package, consider the complete kit, which includes chain, bar and depth gauge (listed above).
	SV789-20	20" 410 mm	See weights above	DeWalt: FLEXVOLT DCCS677 Chainsaw	

\*KNOW YOUR TYPE: Be sure to specify whether your 16" DeWalt Cordless Chainsaw is a TYPE 1 or TYPE 2 when ordering conversion kit. (Find on serial number label.)

**PATENT PENDING**



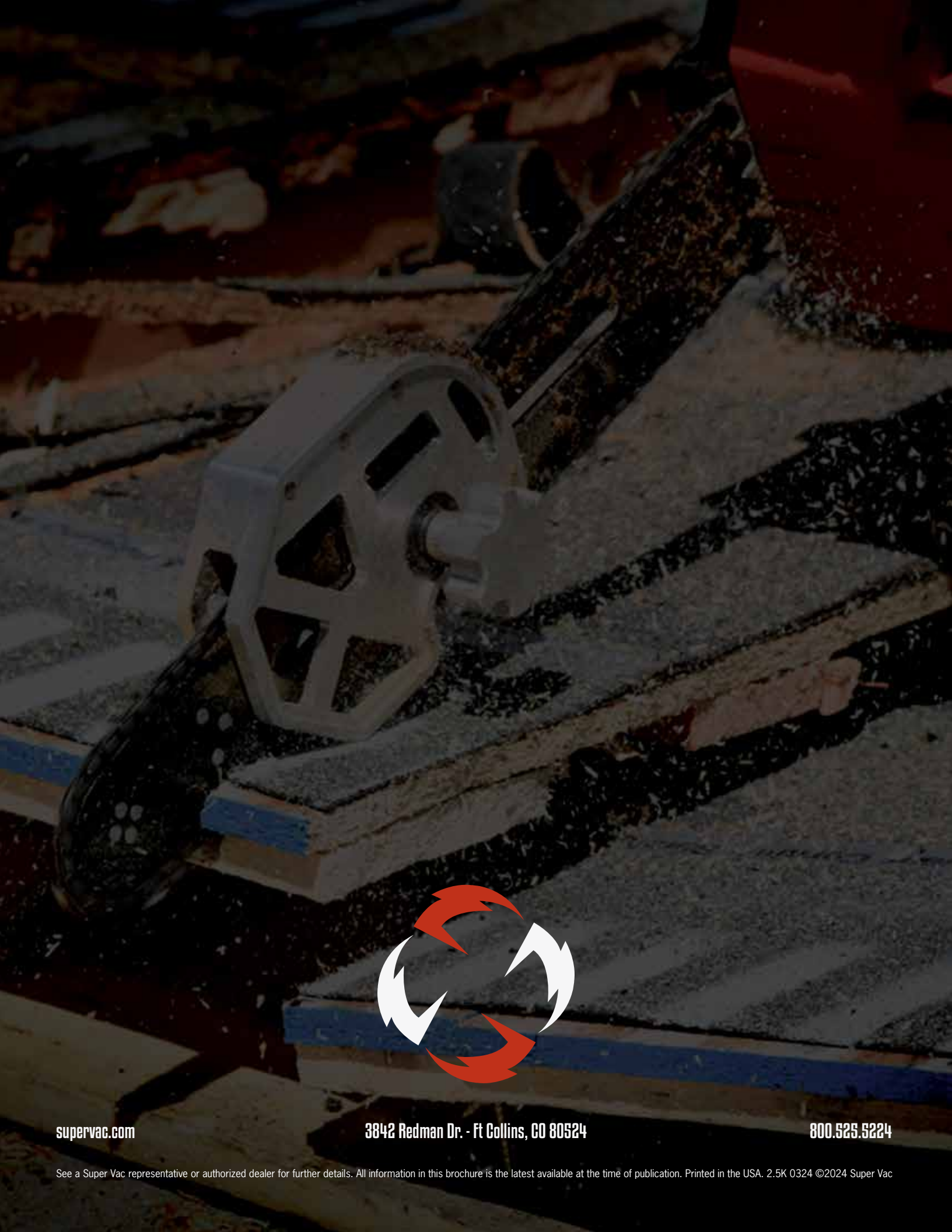

[supervac.com](http://supervac.com)

3842 Redman Dr. - Ft Collins, CO 80524

800.525.5224

See a Super Vac representative or authorized dealer for further details. All information in this brochure is the latest available at the time of publication. Printed in the USA. 2.5K 0324 ©2024 Super Vac